

OPERATOR'S MANUAL



PNEUTORQUE®

PTS™

500/800/1000/1350/2000/2700/4000/6000/7000



CONTENTS

Part Numbers Covered By This Manual	2
Single Speed Tools	2
Auto Two Speed Tools	2
Safety	3
General Safety Rules	3
Projectile Hazards	3
Entanglement Hazards	3
Operating Hazards	3
Repetitive Motions Hazards	4
Accessory Hazards	4
Workplace Hazards	4
Dust and Fume Hazards	4
Noise Hazards	5
Vibration Hazards	5
Additional Safety Instructions for Pneumatic Power Tools	5
PTS Specific Safety Instructions	6
Markings on Tool	6
Introduction	7
Parts Included	7
Explanation of Data Label	7
Accessories	8
Features and Functions	10
Set Up Instructions	11
1. Connecting Air Supply	11
2. Air Lubrication	12
3. Torque Reaction	12
4. Clockwise/Counter Clockwise Operation	15
5. Setting Torque to Tighten Fastener	15
Operating Instructions	16
Tightening	16
Releasing	17
Dual Trigger Tools	18
Maintenance	19
Air Lubrication	19
Gearbox	19
Silencers	19
Drive Square	22
Calibration	22
Cleaning	22
Disposal	22
Specifications	23
Single Speed Tools	23
Auto Two Speed Tools	24
Declaration of Conformity	26
Trouble Shooting	27
Glossary of Terms	27

PART NUMBERS COVERED BY THIS MANUAL

This manual covers the setup and use of Norbar PneuTorque® PTS stall tools.

NOTE: Diagrams and photographs are shown for illustrative purposes only and do not form part of any contractual specification. The model shown may differ from the model that you have purchased.

Single Speed Tools

Part Number	Model	Direction	Maximum Torque
180241.B06	PTS-52-500	Bi-directional	500 N·m
180242.B06	PTS-52-800	Bi-directional	800 N·m
180243.B06	PTS-72-1000	Bi-directional	1,000 N·m
180244.B08	PTS-72-1350	Bi-directional	1,350 N·m
181454	PTS-68-2000	Bi-directional	2,000 N·m
180246.B08	PTS-80-2700	Bi-directional	2,700 N·m
180250.B08	PTS-92-4000	Bi-directional	4,000 N·m
180250.B12	PTS-92-4000	Bi-directional	4,000 N·m
180248.B12	PTS-119-6000	Bi-directional	6,000 N·m
180249.B12	PTS-119-7000	Bi-directional	7,000 N·m

Auto Two Speed Tools

Part Number	Model	Direction	Maximum Torque
180781	PTS-72-1000-AUT-¾" SQ DR	Bi-directional	1,000 N·m
180782	PTS-72-1350-AUT-¾" SQ DR	Bi-directional	1,350 N·m
180784	PTS-80-2700-AUT-1" SQ DR	Bi-directional	2,700 N·m
180785	PTS-92-4000-AUT-1" SQ DR	Bi-directional	4,000 N·m
180786	PTS-92-4000-AUT 1 ½" SQ DR	Bi-directional	4,000 N·m
180787	PTS-119-6000-AUT-1 ½" SQ DR	Bi-directional	6,000 N·m
180788	PTS-119-7000-AUT-1 ½" SQ DR	Bi-directional	7,000 N·m

NOTE: The main PTS models are listed above. Other PTS stall tools with minor variances are also covered.

Part Number Convention, Single Speed Tools Only:

Part Number Option	Description
****.B**	Bi-directional
****.*06	¾" A/F drive square drive
****.*08	1" A/F drive square drive
****.*12	1 ½" A/F drive square drive
*****.DTM	Dual Trigger

Model Naming Convention:

Model Option	Description
PTS**-***_*	PneuTorque® PTS
PTS*-52-****_*	52 mm diameter gear box
PTS*-68-****_*	68 mm diameter gear box
PTS*-72-****_*	72 mm diameter gear box
PTS*-80-****_*	80 mm diameter gear box
PTS*-92-****_*	92 mm diameter gear box
PTS*-119-****_*	119 mm diameter gear box
PTS**-**-1000-*	Maximum torque in N·m

****.*06
 ****.*08
 ****.*12

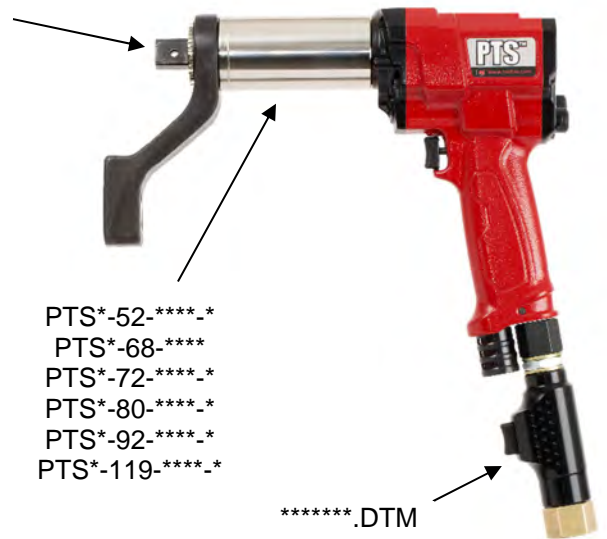

PTS*-52-****_*
 PTS*-68-****_*
 PTS*-72-****_*
 PTS*-80-****_*
 PTS*-92-****_*
 PTS*-119-****_*

*****.DTM

SAFETY

IMPORTANT: THIS OPERATOR'S MANUAL SHOULD BE KEPT FOR FUTURE REFERENCE.

General Safety Rules:

- For multiple hazards, read and understand the safety instructions before installing, operating, repairing, maintaining, changing accessories on, or working near the assembly power tool for threaded fasteners. Failure to do so can result in serious bodily injury.
- Only qualified and trained operators should install, adjust or use the assembly power tool for threaded fasteners.
- Do not modify this assembly power tool for threaded fasteners. Modifications can reduce the effectiveness of safety measures and increase the risks to the operator.
- Do not discard the safety instructions; give them to the operator.
- Do not use the assembly power tool for threaded fasteners if it has been damaged.
- Tools shall be inspected periodically to verify that the ratings and markings required are legibly marked on the tool. The employer/user shall contact the manufacturer to obtain replacement marking labels when necessary.

Projectile Hazards:

- Failure of the workpiece, of accessories or even of the tool itself can generate high-velocity projectiles.
- Always wear impact-resistant eye protection during the operation of the assembly power tool for threaded fasteners. The grade of protection required should be assessed for each use.
- Ensure that the workpiece is securely fixed.

Entanglement Hazards:

- Entanglement hazards can result in choking, scalping and/or lacerations if loose clothing, personal jewellery, neckware, hair or gloves are not kept away from the tool and accessories.
- Inappropriate gloves can become entangled with the rotating drive, causing severed or broken fingers.
- Rotating drive sockets and drive extensions can easily entangle rubber-coated or metal-reinforced gloves.
- Do not wear loose-fitting gloves or gloves with cut or frayed fingers.
- Never hold the drive, socket or drive extension.
- Keep hands away from rotating drives.

Operating Hazards:

- The use of the tool can expose the operator's hands to hazards including crushing, impacts, cuts and abrasions and heat. Wear suitable gloves to protect hands.
- These tools require the use of a suitable reaction which presents a crushing hazard. Ensure to follow the set up instructions in this manual.
- Operators and maintenance personnel shall be physically able to handle the bulk, weight and power of the tool.
- Hold the tool correctly; be ready to counteract normal or sudden movements and have both hands available.

- Maintain a balanced body position and secure footing.
- Release the trigger in the case of an interruption of the energy supply.
- Use only lubricants recommended by the manufacturer.
- Do not use in confined spaces and beware of crushing hands between tool and workpiece.

Repetitive Motions Hazards:

- When using a power tool for threaded fasteners, the operator can experience discomfort in the hands, arms, shoulders, neck, or other parts of the body.
- While using an assembly power tool for threaded fasteners, the operator should adopt a comfortable posture whilst maintaining secure footing and avoiding awkward or off-balanced postures. The operator should change posture during extended tasks, which can help avoid discomfort and fatigue.
- If the operator experiences symptoms such as persistent or recurring discomfort, pain, throbbing, aching, tingling, numbness, burning sensations or stiffness, these warning signs should not be ignored. The operator should tell the employer and consult a qualified health professional.

Accessory Hazards:

- Disconnect the assembly power tool for threaded fasteners from the energy supply before changing the tool or accessory.
- Use only sizes and types of accessories and consumables that are recommended by the assembly power tool for threaded fasteners manufacturer; do not use other types or sizes of accessories and consumables.

Workplace Hazards:

- Slips, trips and falls are major causes of workplace injury. Be aware of slippery surfaces caused by the use of the tool and also of trip hazards caused by the air line or hydraulic hose.
- Proceed with care in unfamiliar surroundings. Hidden hazards, such as electricity or other utility lines, can exist.
- The assembly power tool for threaded fasteners is not intended for use in potentially explosive atmospheres and is not insulated against coming into contact with electrical power.
- Make sure there are no electrical cables, gas pipes, etc., that can cause a hazard if damaged by use of the tool.

Dust and Fume Hazards:

- Dust and fumes generated when using assembly power tools for threaded fasteners can cause ill health (for example, cancer, birth defects, asthma and/or dermatitis); risk assessment and implementation of appropriate controls for these hazards are essential.
- Risk assessment should include dust created by the use of the tool and the potential for disturbing existing dust.
- Direct the exhaust so as to minimize disturbance of dust in a dust-filled environment.
- Where dust or fumes are created, the priority shall be to control them at the point of emission.
- All integral features or accessories for the collection, extraction or suppression of airborne dust or fumes should be correctly used and maintained in accordance with the manufacturer's instructions.
- Use respiratory protection in accordance with employer's instructions and as required by occupational health and safety regulations.

Noise Hazards:

- Unprotected exposure to high noise levels can cause permanent, disabling, hearing loss and other problems, such as tinnitus (ringing, buzzing, whistling or humming in the ears). Therefore a risk assessment and implementation of appropriate controls for these hazards are essential.
- Appropriate controls to reduce the risk may include actions such as damping materials to prevent workpieces from “ringing”.
- Use hearing protection in accordance with employer's instructions and as required by occupational health and safety regulations.
- Operate and maintain the assembly power tool for threaded fasteners as recommended in the instruction handbook, to prevent an unnecessary increase in noise levels.
- If the assembly power tool for threaded fasteners has a silencer, always ensure it is in place and in good working order when the assembly power tool for threaded fasteners is operating.
- Select, maintain and replace the consumable/tool as recommended in the instruction handbook, to prevent an unnecessary increase in noise.

Vibration Hazards:

- Exposure to vibration can cause disabling damage to the nerves and blood supply of the hands and arms.
- Wear warm clothing when working in cold conditions and keep your hands warm and dry.
- If you experience numbness, tingling, pain or whitening of the skin in your fingers or hands, stop using the assembly power tool for threaded fasteners, tell your employer and consult a physician.
- Operate and maintain the assembly power tool for threaded fasteners as recommended in the instruction handbook, to prevent an unnecessary increase in vibration levels.
- Do not use worn or ill-fitting sockets or extensions, as this is likely to cause an increase in vibration.
- Select, maintain and replace the consumable/tool as recommended in the instruction handbook, to prevent an unnecessary increase in vibration levels.
- Support the weight of the tool in a stand, tensioner or balancer, if possible.
- Hold the tool with a light but safe grip, taking account of the required hand reaction forces, because the risk from vibration is generally greater when the grip force is higher.

Additional Safety Instructions for Pneumatic Power Tools:



- Air under pressure can cause severe injury:
 - Always shut off air supply, drain hose of air pressure and disconnect tool from air supply when not in use, before changing accessories or when making repairs;
 - Never direct air at yourself or anyone else.
- Whipping hoses can cause severe injury. Always check for damaged or loose hoses and fittings.
- Cold air shall be directed away from the hands.
- Air lines with safe disconnect couplings, as supplied, are recommended. Whenever universal twist couplings (claw couplings) are used, lock pins shall be installed and whipcheck safety cables shall be used to safeguard against possible hose-to-tool and hose-to-hose connection failure.
- Do not exceed the maximum air pressure stated on the tool.

- For torque-control and continuous-rotation tools, the air pressure has a safety critical effect on performance. Therefore, requirements for length and diameter of the hose shall be specified.
- Never carry an air tool by the hose.

PTS Specific Safety Instructions:

- This tool is intended for use with threaded fasteners. Other uses within the limits of the tool may be appropriate. Please contact Norbar for guidance.
- The user (or the user's employer) shall assess the specific risks that can be present as a result of each use. This Operator's Manual contains sufficient information for the end user to be able to perform an initial risk assessment.
- Unexpected direction of drive square movement can cause a hazardous situation.
- Isolate the tool from all energy sources before changing or adjusting the drive square or socket.

Markings on Tool







Pictograms on Tool	Meaning
	Read and understand Operator's Manual.
	Unexpected tool movement due to reaction forces or breakage of drive square or reaction bar may cause injuries. There is a risk of crushing between the reaction bar and work piece. Keep hands away from reaction bar. Keep hands away from tool output.

INTRODUCTION

The PneuTorque® PTS tools are non-impacting, air driven power tools designed for applying torque to threaded fasteners. There are models to cover torque capacities of 500 N·m to 7,000 N·m also available with auto two speed gearbox to increase free run speed. The tools use an external air pressure regulator (included in a Lubro Control Unit supplied as an accessory) to set the air pressure that controls the stall torque. The PTS must always be operated with the following:-

- Filtered dry air supply. Minimum recommended compressor rating: 6.9 bar (100 psi), 19 l/s (40 CFM).
- Lubro Control Unit or similar Filter, Regulator and Lubricator Unit ½” Bore (12 mm).
- Impact or high quality sockets.
- Reaction bar.

Parts Included

Description	Model:					
	PTS-52	PTS-68	PTS-72	PTS-80	PTS-92	PTS-119
Visual Difference						
Splined Reaction	18646	19611	19289	19289	19291	19293
Reaction Bar Retaining Circlip	26588	265417	26486	26486	26486	26482
Air Coupling Socket for Hose	28933	28933	28933	28933	28933	28933
Operator's Manual & language USB drive	34438	34438	34438	34438	34438	34438

Explanation of Data Label:



A: Norbar Serial Number (First 4 digits = Year of manufacture).

B: Norbar Part Number, including reference to square drive size. (Only single speed tools [with the exception of PTS™-68] include the reference to square drive size in their part number e.g. B06).

C: Maximum calibrated Torque value.



D: Maximum rated air pressure.



E: Maximum free-running speed (achieved when tool is set to the air pressure for the max. torque value).

F: Instruction to read operator's manual before use.

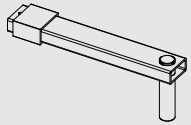
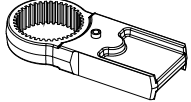
G: CE logo for European conformity.

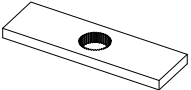
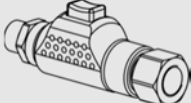
Accessories

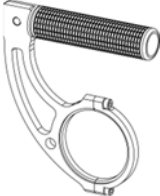
Description	Part Number					
	PTS-52	PTS-68	PTS-72	PTS-80	PTS-92	PTS-119
Air Coupling Socket for Hose	28933	28933	28933	28933	28933	28933
Lubro Control Unit	16074	16074	16074	16074	16074	16074
¾" Drive Square (fixing screw)	18544 (25351.30)	-	18779 (25352.45)	-	-	-
1" Drive Square (fixing screw)	18545 (25351.30)	19431 (25352.45)	18492 (25352.45)	19431 (25352.40)	18934 (25352.60)	-
1 ½" Drive Square (fixing screw)	-	-	-	-	18935 (25352.60)	18959 (25352.80)
Reaction Bar [NOTE 1] 	18298	-	18298	-	-	-
Reaction Adaptor [NOTE 1] 	18558	-	18290	-	-	-
Single-Sided Reaction Plate 	18576	-	18292	18292	18979	16687
Double-Sided Reaction Plate 	18590	-	18293	18293	18980	18981
Dual Trigger Module 	19286	19286	19286	19286	19286	19286
6" Blade Nose Extension	(¾") 18601.006	-	(1") 19007.006	-	-	-
9" Blade Nose Extension	(¾") 18601.009	-	(1") 19007.009	(1") 19480.009	-	-
12" Blade Nose Extension	(¾") 18601.012	-	(1") 19007.012	(1") 19480.012	-	-
6" Splined Nose Extension	(¾") 19045.006	-	(¾") 19046.006 (1") 19285.006	-	(1") 19047.006	-
9" Splined Nose Extension	(¾") 19045.009	-	(¾") 19046.009 (1") 19285.009	-	(1") 19047.009	-

Description	Part Number					
	PTS-52	PTS-68	PTS-72	PTS-80	PTS-92	PTS-119
12" Splined Nose Extension	($\frac{3}{4}$ " 19045.012	-	($\frac{3}{4}$ " 19046.012 (1" 19285.012	-	(1" 19047.012	-
9" Nose Extension for Truck & Bus Wheels	-	-	($\frac{3}{4}$ " 19087.009 (1" 19089.009	-	-	-
12" Nose Extension for Truck & Bus Wheels	-	-	($\frac{3}{4}$ " 19087.012 (1" 19089.012	-	-	-
Lifting Handle 	-	-	19363	19448	19363	19363
Lightweight aluminium Reaction 	-	-	18494	18494	18936	18961 [NOTE 2]

NOTE 1: Requires both the 'Reaction Bar' and 'Reaction Adaptor' to be used together.

NOTE 2: Max torque 6,000 N·m.

FEATURES AND FUNCTIONS

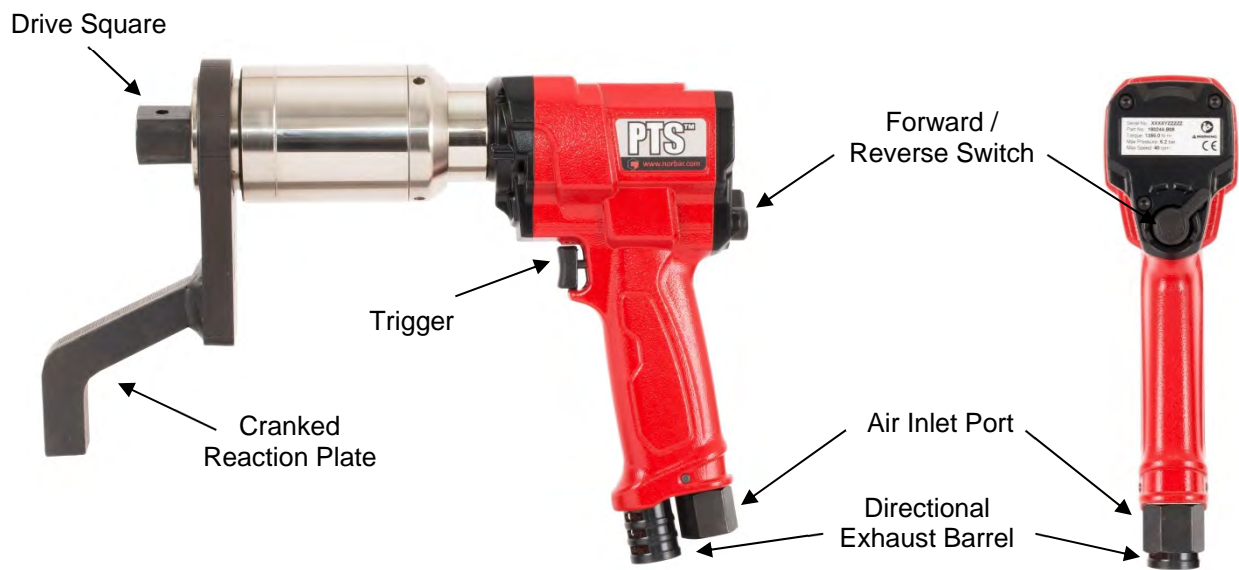

- A single efficient bi-directional air motor.
- Auto two speed option for faster bolting. (Available on most models)
- Excellent power to weight ratio.
- $\pm 3\%$ repeatability. Accuracy better than $\pm 3\%$ (see calibration certificate).
- Handle and trigger design for optimum comfort.
- Directional exhaust barrel directs exhaust away from the operator.
- Very quiet operation reducing the need for protection with sound pressure level from 77dB(A).
- Non impacting – Exceptionally low vibration levels (0.343 m/s) make these tools comfortable and safe for the operator to use. In addition there is less damage to the tool, socket and threaded assembly.
- Fast operation for rapid rundown.
- Easily accessible switch for forward and reverse operation. Enabling the user to drive fasteners in both clockwise or counter clockwise directions facilitating the tightening or loosening of bolts.
- The splined reaction provides fast and safe fitment of alternative reactions.
- Replaceable square drive designed to shear, avoiding internal damage to the tool.
- The lifting handle (optional accessory) can be used to suspend the PneuTorque® from a balancer, or provide 2 handed support.
- Air couplings supplied to allow quick and safe tool connection / disconnection from the air hose without the need to isolate air supplies.
- Models covering 9 torque ranges from 500 N·m up to 7,000 N·m.

SET UP INSTRUCTIONS

The PneuTorque® set up covers the following items:

1. Connecting Air Supply
2. Air Lubrication
3. Torque Reaction
4. Clockwise / Counter Clockwise Operation
5. Setting Torque to Tighten Fastener

Please complete the set up in the order shown.

1. Connecting Air Supply



WARNING: IN ACCORDANCE WITH THE MACHINERY DIRECTIVE WE SUPPLY ALL PTS TOOLS WITH QUICK RELEASE AIR COUPLINGS. DO NOT USE WITHOUT.

Make sure all hoses are clean, in good condition and free from dirt / water.

Connect the tool air inlet hose A (Figure 1) to the outlet side of the lubro control unit B (Figure 1) (not supplied), observing air flow direction arrows.

TIP: Fit the coupling socket to air hose.

To connect, push couplings together.

To disconnect, pull back lock on socket coupling.



Connect the inlet side of the lubro control unit B (Figure 1) to the air supply C (Figure 1) using a minimum hose size of ½" bore (12 mm). Avoid using ½" bore hoses of longer than 5 metres from the supply to the pressure regulator unit as this will reduce the performance of the tool.

Turn on air supply and check for air leaks.

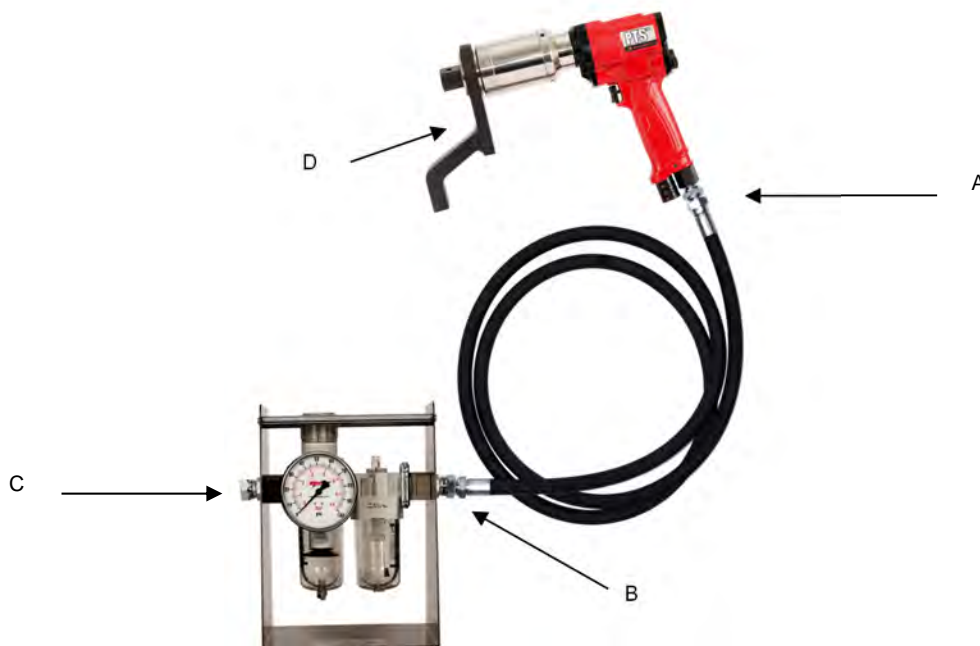

FIGURE 1 – Connections

2. Air Lubrication

The tool must be used with oil lubrication in the supplied air. This is achieved by using a Lubro Control Unit (not supplied).

Set the air lubrication:





- a. Fill Lubro Control Unit with appropriate air-tool grade oil.
- b. Ensure the tool drive is free to rotate.
- c. Run the tool by pressing the trigger – adjust the tool to max pressure according to the setting data
- d. Adjust Lubrication Unit to supply 4 drops of oil per minute.
- e. Release trigger.

See Lubro Control Unit Operator's Manual for more details.

3. Torque Reaction

The splined reaction ensures large reaction forces are contained within the transmission system, a small fraction of reaction torque is also passed back to the user; this provides useful operator feedback as torque levels increase. Several reaction bar styles are available.

Fit reaction bar as detailed below:

Reaction Bar Type	Image	Fitting Instructions
Cranked steel reaction bar (standard)		
Cranked aluminium reaction bar (optional)		Fit reaction bar / plate D (Figure 1) over the drive square to engage reaction splines Secure with circlip supplied
Single sided reaction plate (optional)		
Double sided reaction plate (optional)		
Nose Extension (optional)		Fit as instructions supplied with nose extension

It is essential the reaction bar rests squarely against a solid object or surface adjacent to the fastener to be tightened.

DO NOT react on the surface circled in red on Figure 2.

React on the end of the reaction bar, circled in green on Figure 2, using the maximum area possible.

The ideal reaction arrangement has the centre of the reaction bar and the centre of the nut on a perpendicular line to the centre line of the tool, see Figure 3.

The supplied reaction bar has been designed to give an ideal reaction point when used with a standard length socket.

To allow for a small difference in socket length the reaction bar may contact any point within the shaded area of Figure 3.



WARNING: IF THE REACTION POINT IS OUTSIDE THE SHADED AREA EXCESSIVE LOADS MAY BE PLACED ON THE TOOL LEADING TO POTENTIAL OPERATOR INJURY AND DAMAGE TO THE TOOL.

If an extra long socket is used it may move the reaction bar outside the safe reaction window, as seen in Figure 4.

The standard reaction bar may need to be extended to ensure it remains within the shaded area.

For alternative reaction bars see ACCESSORIES list.



WARNING: IF MODIFYING THE STANDARD REACTION BAR ENSURE IT IS CAPABLE OF TAKING THE MAXIMUM LOAD OF THE TOOL. FAILURE OF THE REACTION BAR CAN ENDANGER OPERATOR SAFETY AND DAMAGE THE TOOL.

Standard drive square extensions, see Figure 5, MUST NOT be used as these will cause serious damage to the tool output drive.

A range of nose extensions is available for applications where access is restricted. These are designed to support the final drive correctly.



FIGURE 5 – Drive Square Extension



FIGURE 2 – Cranked Reaction Bar (Steel or Aluminium)



FIGURE 3 – Standard Length Socket Safe Reaction Window



FIGURE 4 – Extra Long Socket Safe Reaction Window

The dimensions of the standard reaction bars are shown in the following table:

Reaction Bars (Standard)	Tool	Dimensions (mm)				'SQ'
		'L'	'A'	'B'	'W'	
	PTS-52	59	131	71	35	¾"
	PTS-68	74	165	120	30	1"
	PTS-72	69 74	167	114	29	¾" 1"
	PTS-80	74	167	114	29	1"
	PTS-92	69	175	115	29	1" 1 ½"
	PTS-119	90	210	150	35	1 ½"

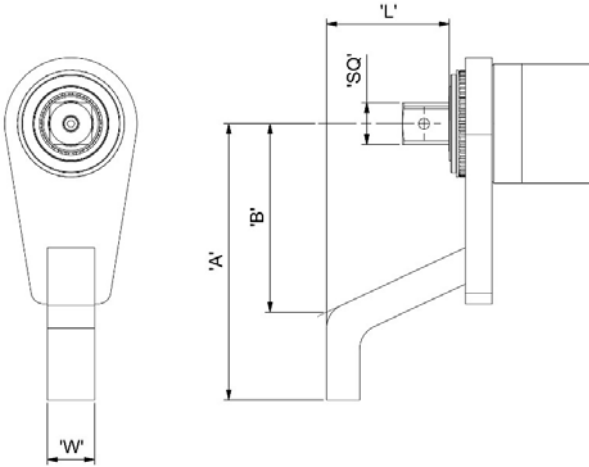

Torque Reaction



FIGURE 6(a)



FIGURE 6(b)



WARNING: ALWAYS KEEP HANDS CLEAR OF THE REACTION BAR WHEN THE TOOL IS IN USE OR SERIOUS INJURY MAY RESULT.



4. Clockwise/Counter-Clockwise Operation

Set clockwise / counter-clockwise as required.



FIGURE 7(a) – Clockwise
(Lever pointing to the right)



FIGURE 7(b) – Counter - Clockwise
(Lever pointing to the left)



WARNING: FAILURE TO FULLY ENGAGE THE CLOCKWISE/COUNTER-CLOCKWISE OPERATION SELECTOR WILL RESULT IN REDUCED AIR FLOW AND INCORRECT TORQUE APPLICATION.

5. Setting Torque to Tighten Fastener

The torque created by the PneuTorque® depends on the air pressure setting. All tools are supplied with setting data that gives the air pressure required to produce the correct torque output.

Set the torque output as follows:-

1. Use the setting data (supplied) to find the air pressure to achieve the required torque.

North Torque Tools Ltd
100, New Road | Banbury | Oxfordshire OX15 3JU | UK
T: +44 (0)1295 219523 | E: enq@northtorque.com
www.northtorque.com

METRIC CERTIFICATE OF CALIBRATION

Model: 190786 **PTS-92-4000-AUT 1"**
Serial No.: 1234567
Maximum Torque Capacity (N-m): 4000.0
Maximum Air Pressure (bar): 6.44
Date of Calibration: 11 Apr 2022
Direction of Rotation: **Clockwise**

Set Air Pressure (bar)	Nominal Torque (N-m)	Tolerance		Actual Readings		
		Min	Max			
0.96	800.0	776.0	824.0	813.0	820.0	804.0
2.96	2400.0	2328.0	2472.0	2419.0	2364.0	2454.0
6.44	4000.0	3880.0	4120.0	4081.0	3963.0	3967.0

A. These torque tools are calibrated or available random torque testers. Each tool prior to its specified to still (the tool under test) internal calibration procedures are used and are displayed adjacent to the torque tester.

The torque test equipment used in the performance of the above calibration on this international traceability through the following calibration laboratory which is UKAS-accredited to ISO 17025:2017.

UKAS Laboratory No.: 0256
Serial No.: 88895 Transducer: 85528 Air Pressure Gauge: 84781001
Cert No.: 269150 285209 & 256223 84781001

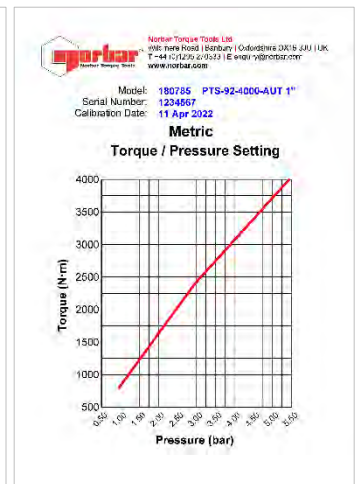

2. With the tool running, adjust the Lubro Control Unit (not included) until the correct air pressure is shown on the gauge.



IMPORTANT: THE TOOL MUST BE FREE RUNNING WHILE ADJUSTING THE AIR PRESSURE TO GIVE THE CORRECT SETTING.

IMPORTANT: CHECK THAT THE LUBRO CONTROL UNIT IS SUPPLYING APPROXIMATELY FOUR DROPS OF OIL PER MINUTE WHILE THE TOOL IS FREE RUNNING.

OPERATING INSTRUCTIONS



WARNING: KEEP HANDS CLEAR OF THE REACTION BAR.



WARNING: WHEN USING THIS TOOL IT MUST BE SUPPORTED AT ALL TIMES IN ORDER TO PREVENT UNEXPECTED RELEASE IN THE EVENT OF FASTENER OR COMPONENT FAILURE.



WARNING: BEFORE USING TOOL, WEAR SUITABLE PPE, INCLUDING SAFETY SHOES, EYE PROTECTION, GLOVES AND OVERALLS.



WARNING: IF EQUIPMENT IS USED IN A MANNER NOT SPECIFIED BY THE MANUFACTURER, INJURY OR DAMAGE COULD RESULT.

Tightening

1. Fit the PneuTorque® with the correct size impact or high quality socket to suit fastener.

TIP: For added safety it is recommended to secure the socket to the square drive. This is often achieved using a pin and O-ring, see socket manufacturer for guidance. The drive squares all include a hole to accommodate a socket retaining pin. (Note: Socket & retaining pin not included)

TIP: The exhaust air (containing oil) is expelled from the tool at the bottom of the handle. The exhaust barrel can rotate to allow the operator to direct the flow of air away from them.

2. Ensure the Clockwise/Counter-clockwise selector is correctly set.
3. Rotate the handle into a convenient position relative to the reaction bar. Fit the tool onto the fastener to be tightened with the reaction bar adjacent to the reaction point. See Figure 8.
4. Adopt a suitable posture to counteract normal or unexpected movement of the tool due to reaction forces.
5. Squeeze the trigger partially to bring the reaction bar into contact with the reaction point.
6. Fully press trigger and keep fully pressed until tool stalls then release trigger.

If the trigger is not fully pressed full torque will not be applied to the fastener.

7. Remove the tool from the fastener.

TIP: Air flow can cool the handle. It is recommended that the operator wear suitable gloves.

TIP: In the event that lubrication fails and / or contaminated air (e.g. water) enters the tool it is strongly recommended that the tool is free run on a clean, dry and lubricated air supply for several minutes.



FIGURE 8 – Clockwise Operation

Releasing

1. Fit the PneuTorque® with the correct size impact or high quality socket to suit the fastener to be released.

TIP: For added safety it is recommended to secure the socket to the square drive. This is often achieved using a pin and O-ring, see socket manufacturer for guidance. The drive squares all include a hole to accommodate a socket retaining pin. (Note: Socket & retaining pin not included)

2. Ensure the clockwise/counter-clockwise selector is correctly set.
3. Rotate the handle into a convenient position relative to the reaction bar. Fit the tool onto the fastener to be released with the reaction bar adjacent to the reaction point. See Figure 9.
4. Adopt a suitable posture to counteract normal or unexpected movement of the tool due to reaction forces.
5. Squeeze the trigger partially to bring the reaction bar into contact with the reaction point.
6. Fully press trigger and keep fully pressed until threaded fastener releases.

TIP: If unable to release the fastener, increase the air pressure to the tool. Do not exceed the maximum air pressure for the tool, located on the tools calibration certificate. Do not confuse the tools maximum air pressure for the 'Rated Air Pressure (Max)' on the tool label.



WARNING: EXCEEDING THE MAXIMUM AIR PRESSURE WILL CAUSE OVERLOADING AND MAY LEAD TO SERIOUS DAMAGE.



WARNING: CHANGING THE AIR PRESSURE AFTER SETTING THE PRESSURE REGULATOR WILL CHANGE THE STALL TORQUE VALUE.



FIGURE 9 – Counter-Clockwise Operation

Dual Trigger Tools

Tools purchased with a Dual Trigger Module (DTM) pre-fitted are identified with the part number suffix .DTM

Tools purchased with a DTM pre-fitted are calibrated at Norbar with the DTM in place. This is because the DTM itself creates a pressure drop which would alter any previously determined calibration data.



WARNING: IF A TOOL IS PURCHASED WITH A DTM FITTED (AS A .DTM TOOL) AND THE USER WANTS TO REMOVE THE MODULE AND USE THE TOOL WITHOUT IT, A NEW CALIBRATION IS REQUIRED. IN THIS SCENARIO CONTACT NORBAR OR YOUR NORBAR DISTRIBUTOR.

With the DTM fitted the tool will not operate unless both the trigger on the DTM and the tool trigger are pressed simultaneously.

As with the tool trigger, the DTM trigger must be fully pressed so as not to affect the air flow, pressure, and ultimately the torque output (See Figure 10):



FIGURE 10 – PTS fitted with Dual Trigger Module

MAINTENANCE

For optimum performance and safety, regular tool maintenance is required. The user maintenance is limited to the replacement of the drive square and the silencers. Any other maintenance or repairs should be carried out by Norbar or a Norbar approved distributor. Maintenance intervals will depend on the tool usage and the environment in which it is being used:

- The maximum recommended service and recalibration interval is 12 months OR 10,000 cycles, whichever occurs first.
- If tool exhibits abnormal performance please contact your Norbar approved distributor.

TIP: Steps the user can take to reduce the amount of maintenance required include:

1. Use the tool in a clean environment.
2. Use an air compressor fitted with a dryer.
3. Ensure the Lubro Control Unit has sufficient hydraulic oil.
4. Ensure the Lubro Control Unit delivers hydraulic oil at the correct rate.
5. Ensure the Lubro Control Unit is regularly maintained, see product manual.
6. Maintain the correct torque reaction.
7. In the event that lubrication fails and / or contaminated air (e.g. water) enters the tool it is strongly recommended that the tool is free run on a clean, dry and lubricated air supply for several minutes.
8. Prior to long periods of storage it is strongly recommended that the tool is free run on a clean, dry and lubricated air supply for several minutes.



WARNING: GLOVES SHOULD BE WORN FOR MAINTENANCE TO AVOID CONTACT WITH GREASE AND OIL.

Air Lubrication

Use appropriate air-tool grade oil. (For Example Shell Tellus S2 V15)

Gearbox

The gearbox is not user-serviceable. For more information on gearbox servicing please contact Norbar or your Norbar approved distributor.

Silencers

The PTS has three silencers (Figure 11) which are intended to last the lifetime of the tool (under optimum operating conditions). However, in adverse operating conditions replacement is recommended if the user experiences a loss of tool performance.

The three silencers can be purchased together as a 'PTS silencer spares kit' (19358):

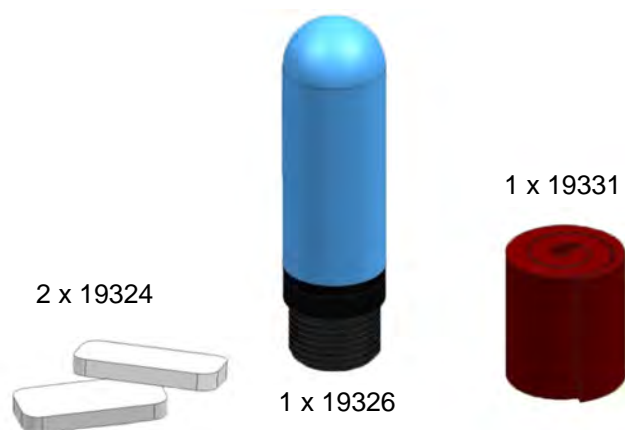

FIGURE 11 - Silencers

Exhaust Barrel Silencer Replacement (#19331):

TIP: Change exhaust barrel silencer with tool upside down, as shown in Figure 12.

1. Remove internal circlip (A) (part number 265148) using a small flathead screwdriver.
2. Remove exhaust barrel cap plate (B) (part number 19330).
3. Pull out silencing media (C) (part number 19331) from the exhaust barrel (D).
4. Fit new silencing media (part number 19331) into exhaust barrel (D) – roll up the media to form a cylinder that fits neatly into the exhaust barrel. Take care not to roll the silencing media too tightly.
5. Replace exhaust barrel cap (B) (part number 19330).
6. Replace internal circlip (A) (part number 265148).

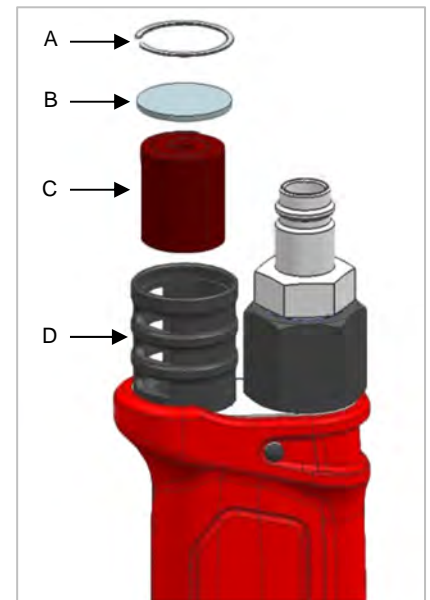

FIGURE 12 – Exhaust Barrel Silencer Replacement

Handle Silencer Replacement (#19326):

TIP: Change handle silencer with tool upside down, as shown in Figure 13. This method avoids the spring and valve falling out of the handle.

1. Remove dowel pin (A) (part number 26321).
2. Remove exhaust barrel sub assembly (B) (part number 19316) and the air inlet tube (C) (part number 19210).
3. Pull the silencer (D) (part number 19326) from the handle. Pliers may help removal.
4. Unscrew the silencer (D) (part number 19326) from the silencer sleeve (E) (part number 19325).
5. Replace the silencer and screw into the silencer sleeve (E) (part number 19325).
6. Insert silencer back into handle. Ensure that silencer sleeve (E) is pushed fully up to stop within handle.
7. Replace exhaust barrel sub assembly together with air inlet tube.
8. Replace dowel pin (A) (part number 26321).

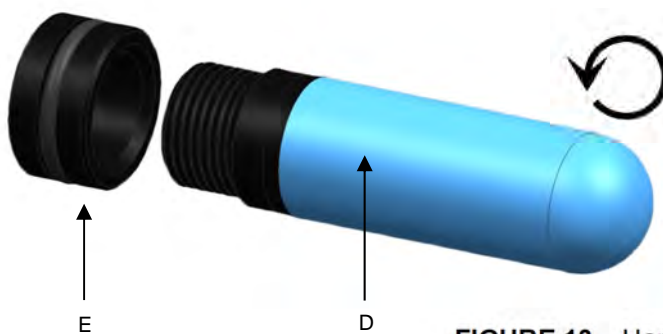
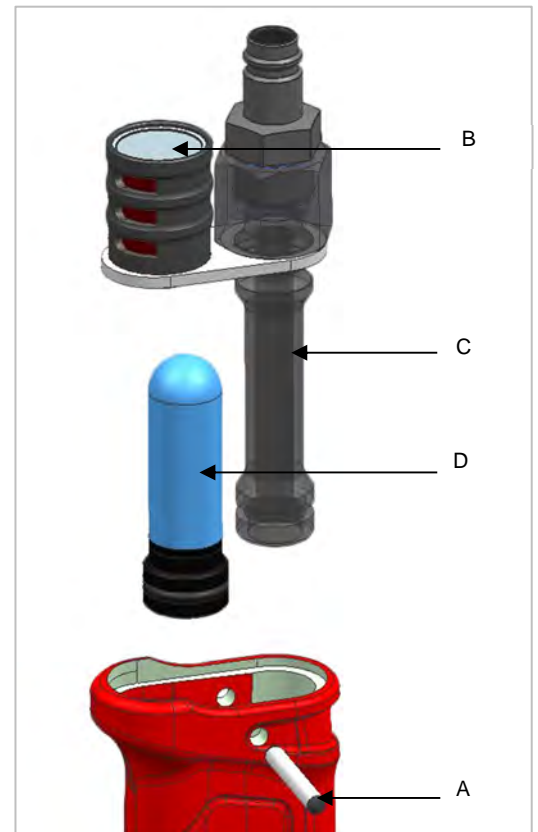

FIGURE 13 – Handle Silencer Replacement

Front Exhaust Silencer Replacement (#19324):

TIP: When removing the gearbox take great care not to allow ingress of dirt or debris. This procedure should only be performed in a clean workshop environment.

1. Remove 5 x M4 Screw (A) (part number 25351.12).
2. Remove the gearbox / front-plate (B) from the handle.
3. Remove 2 x silencers (C) (part number 19324) from the front plate – push out from the front.
4. Insert new silencers (C) (part number 19324) into the front plate. Ensure they are fully inserted and sit level with (or below) the surface.
5. Reassemble the gearbox / front-plate (B) to the handle, taking care to align the holes with corresponding dowels.
6. Fit 5 x M4 Screw into front plate and tighten between 3 N·m to 3.5 N·m

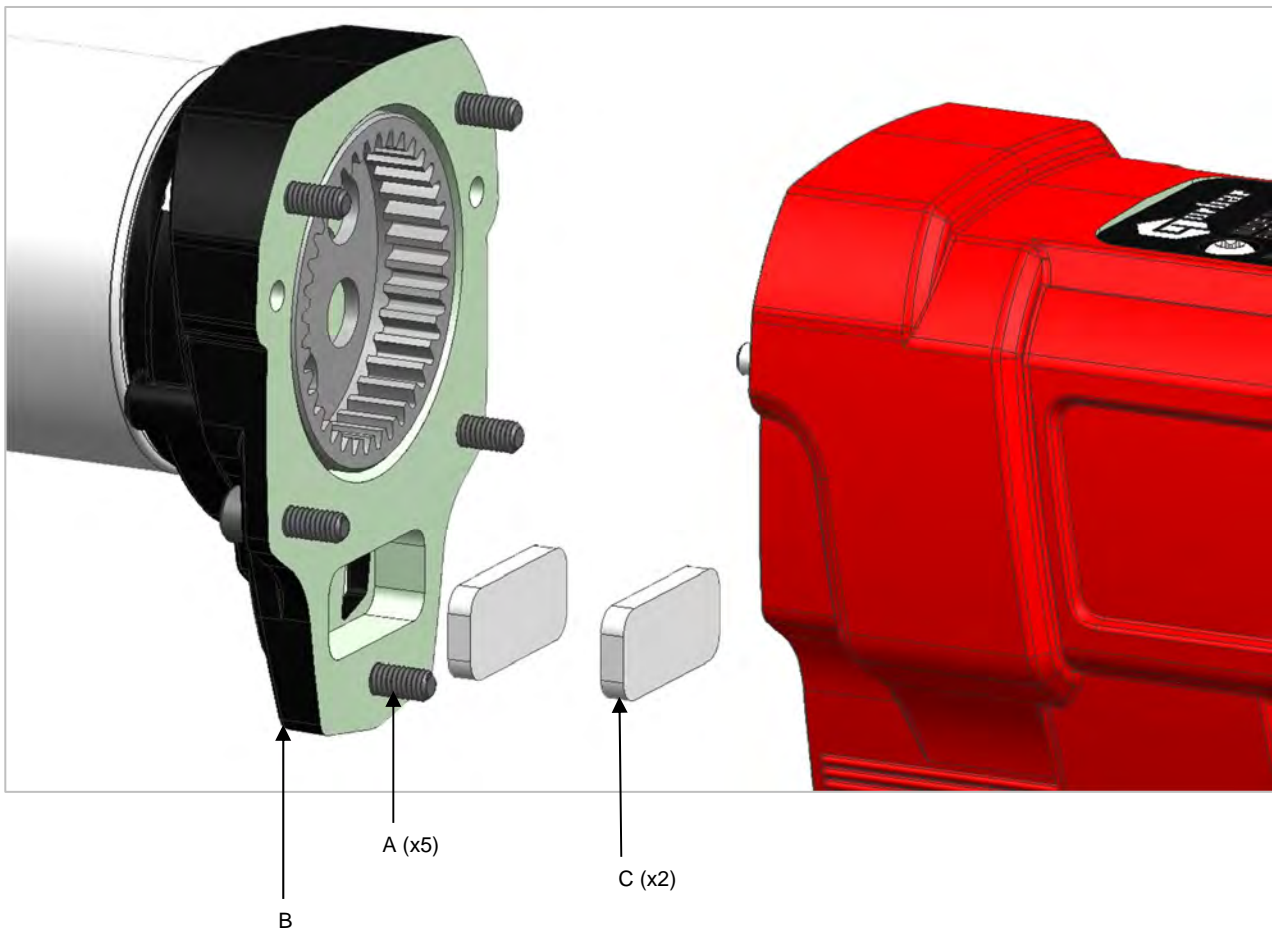

FIGURE 14 – Front Exhaust Silencer Replacement

Drive Square

To avoid internal damage (especially due to torque overload), the output drive square has been designed to shear first. This saves major internal damage and allows easy square removal. For drive square part numbers see page 8.



FIGURE 15 – Square Drive Replacement

To replace drive square:

1. Remove the air supply.
2. Support the tool.
3. Remove the screw, then remove drive square.
If the square has sheared it may be necessary to use pliers to remove the broken parts.
4. Fit new drive square.
5. Fit new screw and tighten between 4 N·m to 5 N·m (for PTS-52) or 8 N·m to 9 N·m (for PTS-68/72/92/80/119).
6. Connect air supply.

TIP: If the drive square fails continually then seek advice from Norbar or a Norbar approved distributor.

Calibration

To maintain the PneuTorque® accuracy it is recommended the tool is recalibrated every 10,000 cycles or annually, whichever comes first. Contact Norbar or a Norbar distributor for more information.

Cleaning

Keep the tool in a clean condition to aid safety. Do not use abrasives or solvent based cleaners.

Disposal

Recycling Considerations: Please recycle where possible.
The tool has no hazardous disposal requirements.

SPECIFICATIONS

Single Speed Tools

Part Number	Model	Square Drive	Torque		Free Run Speed
			Minimum	Maximum	
180241.B06	PTS-52-500	¾"	100 N·m (74 lbf·ft)	500 N·m (370 lbf·ft)	35.5 rev/min
180242.B06	PTS-52-800	¾"	160 N·m (118 lbf·ft)	800 N·m (590 lbf·ft)	25.7 rev/min
180243.B06	PTS-72-1000	¾"	200 N·m (147 lbf·ft)	1,000 N·m (738 lbf·ft)	20.4 rev/min
180244.B08	PTS-72-1350	1"	270 N·m (200 lbf·ft)	1,350 N·m (1,000 lbf·ft)	14.7 rev/min
181454	PTS-68-2000	1"	400 N·m (295 lbf·ft)	2,000 N·m (1,475 lbf·ft)	9.2 rev/min
180246.B08	PTS-80-2700	1"	540 N·m (400 lbf·ft)	2,700 N·m (2,000 lbf·ft)	7.3 rev/min
180250.B08	PTS-92-4000	1"	800 N·m (590 lbf·ft)	4,000 N·m (2,950 lbf·ft)	5.3 rev/min
180250.B12	PTS-92-4000	1 ½"	800 N·m (590 lbf·ft)	4,000 N·m (2,950 lbf·ft)	5.3 rev/min
180248.B12	PTS-119-6000	1 ½"	1,200 N·m (885 lbf·ft)	6,000 N·m (4,425 lbf·ft)	2.6 rev/min
180249.B12	PTS-119-7000	1 ½"	1,400 N·m (1,030 lbf·ft)	7,000 N·m (5,200 lbf·ft)	2.6 rev/min

Part Number	Model	Dimensions (mm)							Tool Weight Without Reaction (kg)	Reaction Weight (kg)
		A	B	ØC	D	E	F	G		
180241.B06	PTS-52-500	264	59	Ø52	131	288	271	69	4.2	0.85
180242.B06	PTS-52-800	263	59	Ø52	131	288	271	69	4.2	0.85
181454	PTS-68-2000	285	74	Ø68	165	315	277	69	5.35	1.1
180243.B06	PTS-72-1000	292	74	Ø72	165	320	283	80	6.24	1.4
180244.B08	PTS-72-1350	292	74	Ø72	165	320	283	80	6.24	1.4
180246.B08	PTS-80-2700	291	74	Ø80	165	326	283	80	6.15	1.4
180250.B08	PTS-92-4000	343	74	Ø92	175	378	289	92	8.95	2.5
180250.B12	PTS-92-4000	343	74	Ø92	175	388	289	92	8.95	2.5
180248.B12	PTS-119-6000	369	90	Ø119	210	407	289	119	12.52	3.8
180249.B12	PTS-119-7000	369	90	Ø119	210	407	289	119	12.52	3.8

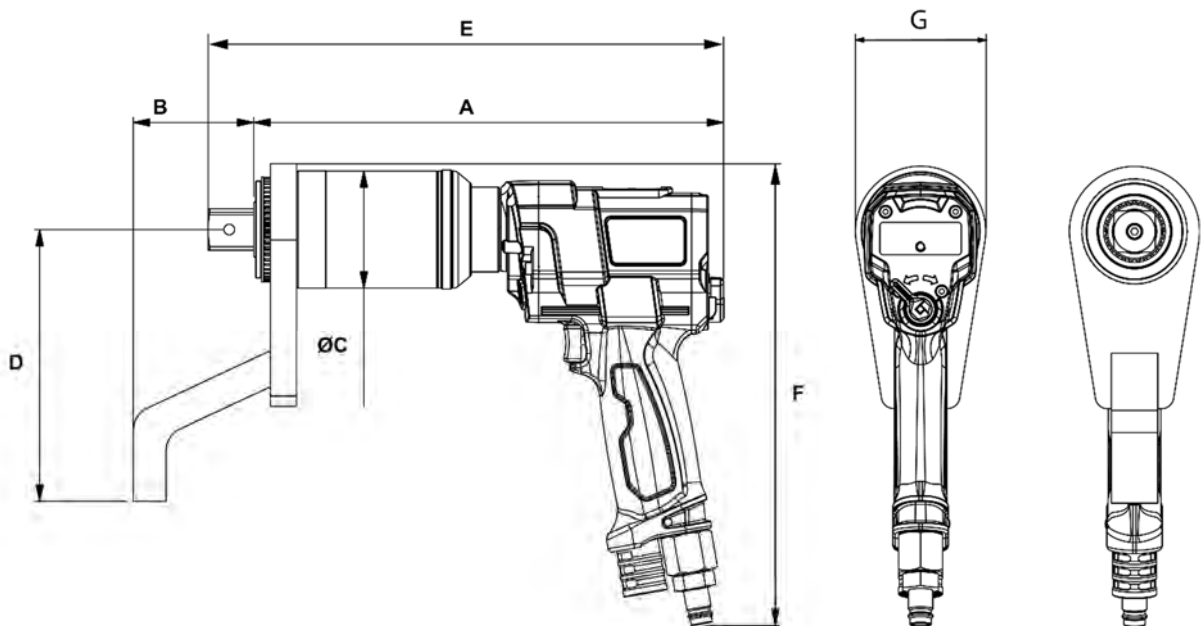

FIGURE 16 – Dimensions

Auto Two Speed Tools

Part Number	Model	Square Drive	Torque		Free Run Speed
			Minimum	Maximum	
180781	PTS-72-1000	¾"	200 N·m (147 lbf·ft)	1,000 N·m (738 lbf·ft)	100 rev/min
180782	PTS-72-1350	¾"	270 N·m (200 lbf·ft)	1,350 N·m (1,000 lbf·ft)	75 rev/min
180784	PTS-80-2700	1"	540 N·m (400 lbf·ft)	2,700 N·m (2,000 lbf·ft)	30 rev/min
180785	PTS-92-4000	1"	800 N·m (590 lbf·ft)	4,000 N·m (2,950 lbf·ft)	22 rev/min
180786	PTS-92-4000	1 ½"	800 N·m (590 lbf·ft)	4,000 N·m (2,950 lbf·ft)	22 rev/min
180787	PTS-119-6000	1 ½"	1,200 N·m (885 lbf·ft)	6,000 N·m (4,425 lbf·ft)	13 rev/min
180788	PTS-119-7000	1 ½"	1,200 N·m (885 lbf·ft)	7,000 N·m (5,160 lbf·ft)	13 rev/min

Part Number	Model	Dimensions (mm)							Tool Weight Without Reaction (kg)	Reaction Weight (kg)
		A	B	ØC	D	E	F	G		
180781	PTS-72-1000	310	74	Ø72	167	338	283	80	6.28	1.4
180782	PTS-72-1350	310	74	Ø72	167	338	283	80	6.28	1.4
180784	PTS-80-2700	327	74	Ø80	167	362	283	80	6.15	1.4
180785	PTS-92-4000	374	75	Ø92	175	409	289	92	8.95	2.5
180786	PTS-92-4000	374	75	Ø92	175	419	289	92	8.95	2.5
180787	PTS-119-6000	369	90	Ø119	210	407	289	119	12.81	3.8
180788	PTS-119-7000	369	90	119	210	407	289	119	12.81	3.8

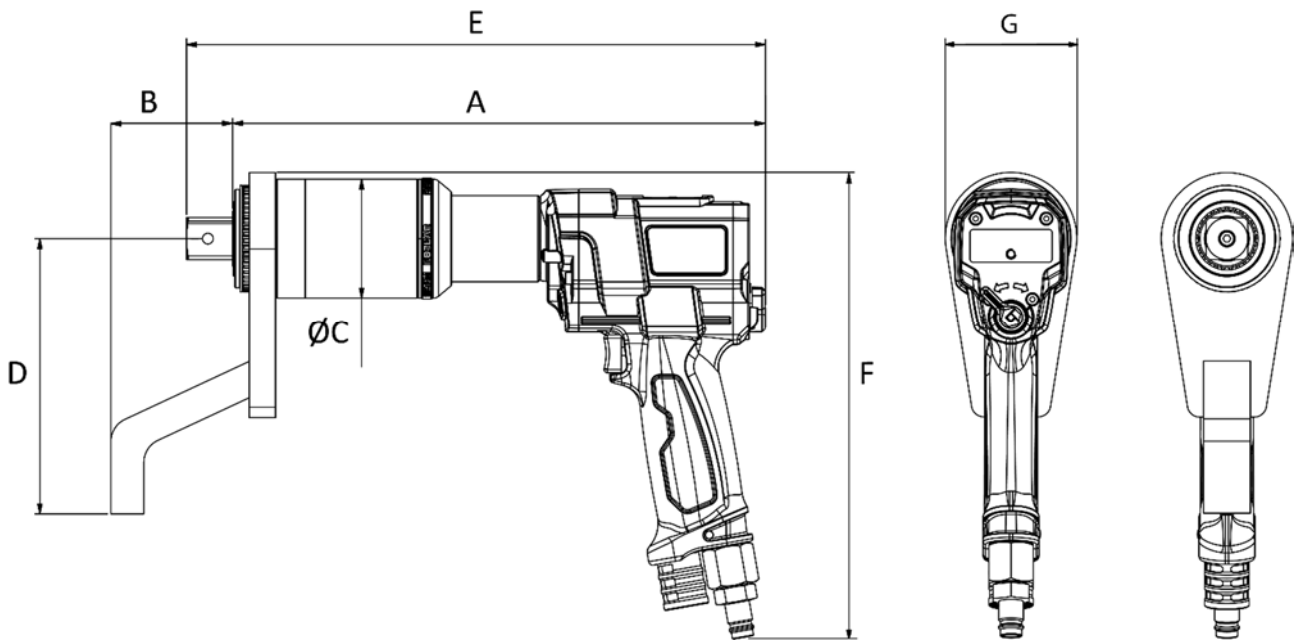

FIGURE 17 – Dimensions

Repeatability:	± 3%
Accuracy:	Accuracy better than ± 3% (see calibration certificate)
Operating Range:	20% to 100% of tool capacity
Air Consumption:	16.5 l/s (35 CFM)
Temperature Range:	0°C to +50°C (operating). -20°C to +60°C (storage).
Operating Humidity:	85% Relative Humidity @30°C maximum.
Handle Vibration:	< 2.5m/s ² measured in accordance with ISO 28927-2. Measured tool vibration (ah) = 0.343 m/s ² with uncertainty (K) = 0.115 m/s ²
Sound Pressure Level:	The sound pressure level is 77 dB(A) uncertainty K = 3dB, measured in accordance with BS EN ISO 11148-6 For the PTS-92 4000Nm this sound pressure level is 79 dB(A) uncertainty K = 3dB, measured in accordance with BS EN ISO 11148-6
Environment:	Store in a clean & dry environment.
Machinery Directive:	In conformance with: BS EN ISO 11148-6:2012 Hand-held non-electric power tools. Safety requirements. Assembly power tools for threaded fasteners.

Due to continuous improvement all specifications are subject to change without prior notice.

DECLARATION OF CONFORMITY

UK Declaration of Conformity (No 0009.1)

The object of the declaration:

PTS. Model Name (Part Number):

PTS-52-500(180241.B06), PTS-52-800 (180242.B06),
PTS-72-1000 (180243.B06 & 180781), PTS-72-1350 (180244.B08 & 180782),
PTS-68-2000 (181454), PTS-72-2000 (180245.B08), PTS-80-2700 (180246.B08 & 180784),
PTS-92-4000 (180250.B08 & 180785), PTS-92-4000 (180250.B12 & 180786),
PTS-119-6000 (180248.B12 & 180787) & PTS-119-7000 (180249.B12 & 180788)

Serial Number – All.

The object of the declaration described above is in conformity with the relevant UK statutory requirements:

Supply of Machinery (Safety) Regulations 2008

The object of the declaration described above has been designed to comply with the following standards:

BS EN ISO 11148-6:2012

The basis on which conformity is being declared:

This declaration of conformity is issued under the sole responsibility of the manufacturer. The technical documentation required to demonstrate that the products meet the requirements of the above legislation has been compiled by the signatory below and is available for inspection by the relevant enforcement authorities.

The UKCA mark was first applied in: 2021.

Signed for and on behalf of Norbar Torque Tools Ltd.

Signed: Trevor Mark Lester B.Eng.
Date: 7 February 2022
Authority: Compliance Engineer
Place: Norbar Torque Tools Ltd., Wildmere Road, Banbury, Oxfordshire. OX16 3JU

EU Declaration of Conformity (No 0009.4)

The object of the declaration:

PTS. Model Name (Part Number):

PTS-52-500(180241.B06), PTS-52-800 (180242.B06),
PTS-72-1000 (180243.B06 & 180781), PTS-72-1350 (180244.B08 & 180782),
PTS-68-2000 (181454), PTS-72-2000 (180245.B08), PTS-80-2700 (180246.B08 & 180784),
PTS-92-4000 (180250.B08 & 180785), PTS-92-4000 (180250.B12 & 180786),
PTS-119-6000 (180248.B12 & 180787) & PTS-119-7000 (180249.B12 & 180788)

Serial Number – All.

The object of the declaration described above is in conformity with the relevant union harmonisation legislation:

Directive 2006/42/EC on Machinery Directive.

The object of the declaration described above has been designed to comply with the following standards:

EN ISO 11148-6:2012

The basis on which conformity is being declared:

This declaration of conformity is issued under the sole responsibility of the manufacturer. The technical documentation required to demonstrate that the products meet the requirements of the above Directives has been compiled by the signatory below and is available for inspection by the relevant enforcement authorities.

The CE mark was first applied in: 2017.

The authorised representative within the European Union (EU) is:

Francesco Frezza Snap-On Equipment Via Prov. Carpi, 33 42015 Correggio RE Italy

Signed for and on behalf of Norbar Torque Tools Ltd.

Signed: Trevor Mark Lester B.Eng.
Date: 7 February 2022
Authority: Compliance Engineer
Place: Norbar Torque Tools Ltd., Wildmere Road, Banbury, Oxfordshire. OX16 3JU

TROUBLE SHOOTING

The following is only a guide, for more complex faults please contact Norbar or a Norbar distributor.

Problem	Cause
Tool output does not rotate when trigger pressed	Check air supply is functioning and connected Check air pressure setting (at least 1 bar (14 psi)) Check correct setting of direction lever Output drive square sheared, needs replacing Gear train or air motor is damaged
Drive square is sheared	See maintenance section to replace drive square
Tool does not stall	Fastener sheared or thread stripped Gear train or air motor is damaged
Free running speed becomes impaired	Silencers are blocked / need replacing

GLOSSARY OF TERMS

Word or Term	Meaning
A/F	Across Flats
Air pressure setting data	Graph and or table supplied with all stall tools to show the air pressure setting to produce required torque
AUT	Auto Two Speed Gearbox
Bi-directional	Tool capable of Clockwise and Counter-clockwise square rotation
Calibration Device	Torque measurement system to display peak torque using a joint simulator or test fastener
Fastener	Bolt or stud to be tightened
Lubro Control Unit	Unit to provide filtering and lubrication along with pressure regulation. Not supplied with tool
Nose Extension	A reaction type used where tool access is restricted, typical examples on wheel nuts on heavy vehicles. Available as an accessory.
PneuTorque®	Product name
PPE	Personal Protective Equipment
PTS	PneuTorque® Single-Motor
Reaction Bar	Item to counteract applied torque. Also called reaction plate
Stall Tool	Tool will stall due to air pressure set.
TBC	To be confirmed
Twist coupling / Claw coupling	A type of air connector. Not recommended by Norbar.

NOTES

NORBAR TORQUE TOOLS LTD

Wildmere Road, Banbury,
Oxfordshire, OX16 3JU

UNITED KINGDOM

Tel + 44 (0)1295 270333

Email enquiry@norbar.com

For the most up-to-date
version of the Operator's
Manual, please scan the
QR code below.



To find your local
Norbar company or
distributor, please scan
the QR code below.



www.norbar.com